



## 6-PANEL (SMOOTH)

Distinguished by more than a quarter century of precise craftsmanship, this classic interior door design rises above all imitators.

6'8" and 8'0" Sizes Available (7'0" height available with extended lead time.)  
 1'4", 1'6", 1'8" and 2'2" not available in 8'0".

1'0"	1'2"	1'3"	1'4"	1'6"	1'8"	1'10"	2'0"	2'2"	2'4"	2'6"	2'8"	2'10"	3'0"
			■	■	■		■		■	■	■	■	■

### Durable, Long Lasting Performance

Made from molded high-density fiberboard, the Haley Bros 6-Panel resists shrinking, swelling cracking and joint separation. Engineered wood designs out performs wood doors while offering *superior value*. Available in standard 6'8" and 8'0" passage sizes with elegant smooth finish.

Haley offers a limited 1-year warranty for quality and craftsmanship on all residential molded panel doors.



Available in 6'8" and 8'0" passage sizes.

Most sizes can be specified for either hollow or solid core construction and with either fingerjoint or MDF stiles and rails.

Elegant smooth finish.

Available in 20, 45 and 60 minute ratings.

All doors are available primed with a low VOC primer; ready to paint.

Covered by a 1-year limited warranty for interior use.

### GREEN BENEFITS

Haley molded door designs (facings) meet Phase 2 of the California Air Resources Board (CARB) Airborne Toxic Control Measure (ATCM) 93120.

Haley molded door designs contain **No Added Urea Formaldehyde (NAUF.)**

All hollow core Haley interior passage content doors contain a minimum of 25% pre-consumer recycled wood fiber content.

### HALEY BROS., INC.

6291 Orangethorpe Ave  
 Buena Park, CA 90620

Ph: 800-854-5951  
 www.haleybros.com  
 info@haleybros.com



## MOLDED DOOR- DIMENSIONAL SPECIFICATIONS

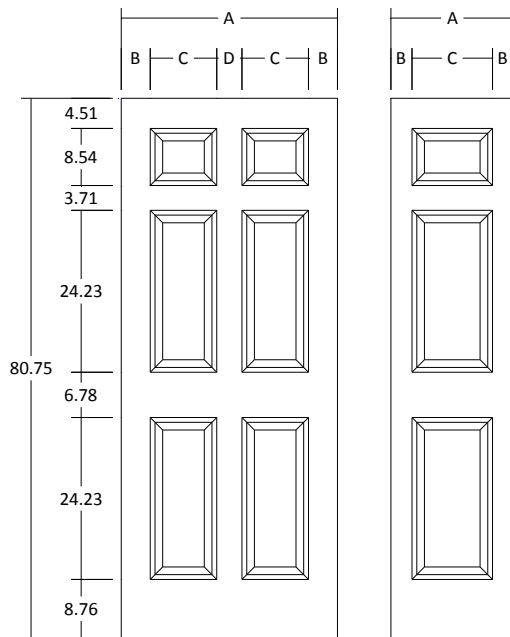

### 6-Panel Smooth 6'8"

Patented INP Profile

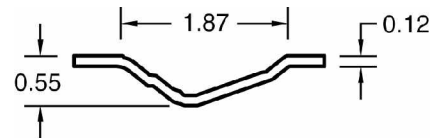

### 6-Panel Smooth 6'8"

MOLDED DOOR DESIGN (DOOR FACING) SIZE

Overall length and width dimensions +/- 1/16"

Nominal	A	B	C	D
36	36.375	4.34	11.96	3.78
34	34.375	5.34	9.96	3.78
32	32.375	4.34	9.96	3.78
30	30.375	4.34	8.96	3.78
28	28.375	4.34	7.96	3.78
26	26.375	5.34	5.96	3.78
24	24.375	4.34	5.96	3.78
20	20.375	4.21	11.96	--
18	18.375	3.21	11.96	--
16 U	16.375	4.69	7.00	--
18/18 B	--	--	--	--
16/16 B	--	--	--	--
15/15 B	--	--	--	--
14/14 B	--	--	--	--
12/12 B	--	--	--	--



## MOLDED DOOR- DIMENSIONAL SPECIFICATIONS

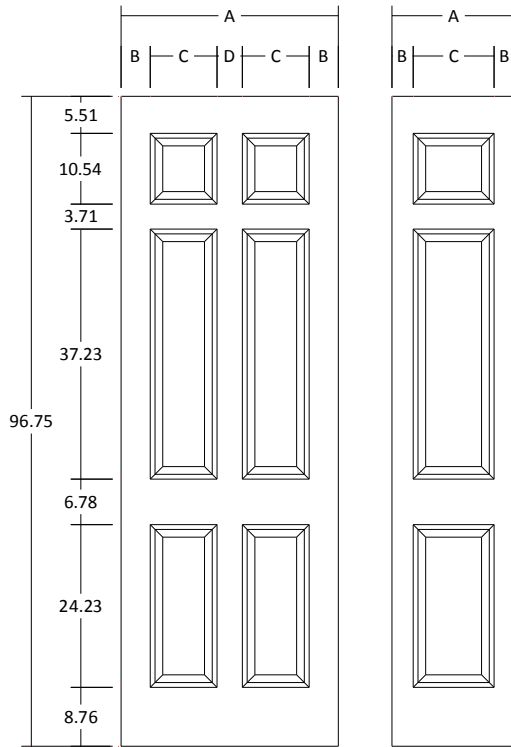

### Colonist Smooth 8'0"

Patented INP Profile

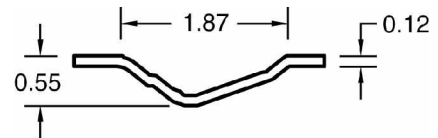

### Colonist Smooth 8'0"

MOLDED DOOR DESIGN (DOOR FACING) SIZE

Overall length and width dimensions +/- 1/16"

Nominal	A	B	C	D
36	36.375	4.34	11.96	3.78
34	34.375	5.34	9.96	3.78
32	32.375	4.34	9.96	3.78
30	30.375	4.34	8.96	3.78
28	28.375	4.34	7.96	3.78
26	26.375	5.34	5.96	3.78
24	24.375	4.34	5.96	3.78
20	20.375	4.21	11.96	--
18	18.375	3.21	11.96	--
16 U	16.375	4.65	7.08	--
18/18 B	--	--	--	--
16/16 B	--	--	--	--
15/15 B	--	--	--	--
14/14 B	--	--	--	--
12/12 B	--	--	--	--



Available in 6'8" and 8'0" passage sizes.

Most sizes can be specified for either hollow or solidcore construction and with either fingerjoint or MDF stiles and rails.

Available in 20, 45 and 60-minute fire ratings.

All doors available primed with a new VOC primer; ready to paint.

Covered by a 1-year limited warranty for interior use.

## COLONIST (TEXTURED)

Distinguished by more than a quarter century of precise craftsmanship, this classic interior door design rises above all imitators.

6'8" and 8'0" Sizes Available (7'0" height available with extended lead time.)  
 1'4", 1'6", 1'8" and 2'2" not available in 8'0".

1'0"	1'2"	1'3"	1'4"	1'6"	1'8"	1'10"	2'0"	2'2"	2'4"	2'6"	2'8"	2'10"	3'0"
			■	■	■		■	■	■	■	■	■	■

### Durable, Long Lasting Performance

Made from molded high-density fiberboard, Colonist resists shrinking, swelling cracking and joint separation. Engineered wood designs out performs wood doors while offering superior value. Available in standard 6'8" and 8'0" passage sizes with pine wood grain textured finish.

Haley offers a limited 1-year warranty for quality and craftsmanship on all residential molded panel doors.

### GREEN BENEFITS

Haley molded door designs (facings) meet Phase 2 of the California Air Resources Board (CARB) Airborne Toxic Control Measure (ATCM) 93120.

Haley molded door designs contain **No Added Urea Formaldehyde (NAUF.)**

All hollow core Haley interior passage content doors contain a minimum of 25% pre-consumer recycled wood fiber content.



### HALEY BROS., INC.

6291 Orangethorpe Ave  
 Buena Park, CA 90620

Ph: 800-854-5951  
 www.haleybros.com  
 info@haleybros.com



## MOLDED DOOR DESIGNS- DIMENSIONAL SPECIFICATIONS

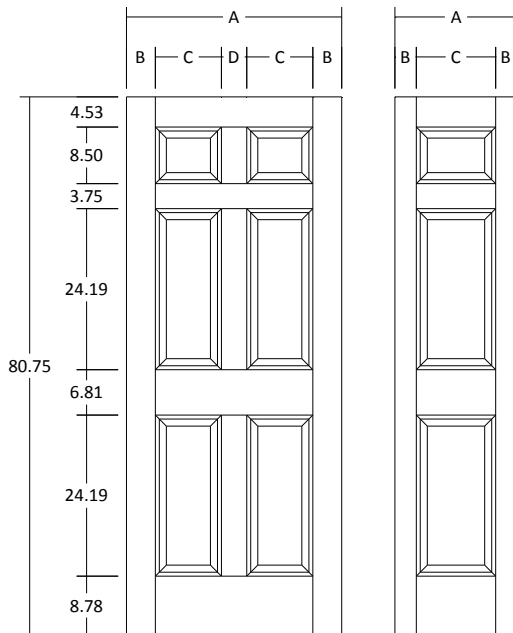

### Colonist Textured 6'8"

Bead and Cove Profile

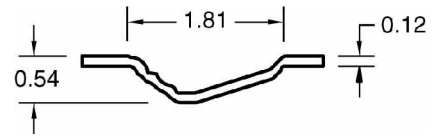

### Colonist Textured 6'8"

MOLDED DOOR DESIGN (DOOR FACING) SIZE

Overall length and width dimensions +/- 1/16"

Nominal	A	B	C	D
36	36.375	4.34	11.94	3.81
34	34.375	5.34	9.94	3.81
32	32.375	4.34	9.94	3.81
30	30.375	4.34	8.94	3.81
28	28.375	4.34	7.94	3.81
26	26.375	5.34	5.94	3.81
24	24.375	4.34	5.94	3.81
20	20.375	4.22	11.94	--
18	18.375	3.22	11.94	--
16 U	16.375	4.69	7.00	--
18/18 B	--	--	--	--
16/16 B	--	--	--	--
15/15 B	--	--	--	--
14/14 B	--	--	--	--
12/12 B	--	--	--	--
9/9 B	18.375	3.22	4.81	2.31



## MOLDED DOOR DESIGNS- DIMENSIONAL SPECIFICATIONS

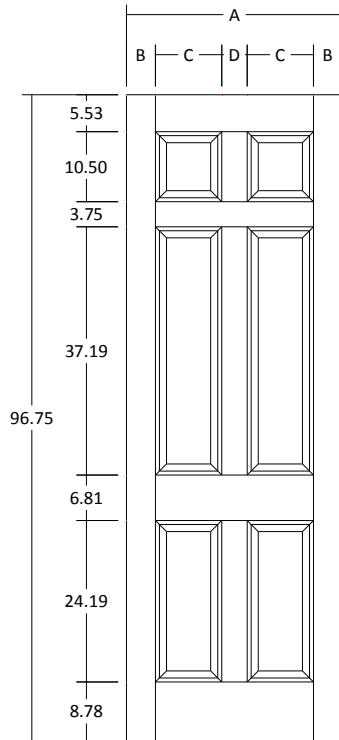

### Colonist Textured 8'0"

Bead and Cove Profile

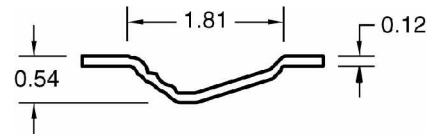

### Colonist Textured 8'0"

MOLDED DOOR DESIGN (DOOR FACING) SIZE

Overall length and width dimensions +/- 1/16"

Nominal	A	B	C	D
36	36.375	4.34	11.94	3.81
34	34.375	5.34	9.94	3.81
32	32.375	4.34	9.94	3.81
30	30.375	4.34	8.94	3.81
28	28.375	4.34	7.94	3.81
26	26.375	5.34	5.94	3.81
24	24.375	4.34	5.94	3.81
20	--	--	--	--
18	--	--	--	--
16 U	--	--	--	--
18/18 B	--	--	--	--
16/16 B	--	--	--	--
15/15 B	--	--	--	--
14/14 B	--	--	--	--
12/12 B	--	--	--	--